



hush.

Sunno

Spec Document



Check the category page

Quiet by Design

Sunno

Sunno is a circular sleek modern ring light, combined with creative acoustical formations to deliver refined aesthetics – speaking to both light and sound.

The durable minimalist design complements interior spaces while maintaining a classy and professional performance.

PRODUCT SPECIFICATIONS

| | |
|-------------------|---|
| Composition | 100% PET (Polyethylene Terephthalate); 60% recycled material |
| Thickness | 12mm |
| Product Placement | Hanging |
| NRC | 0.80 - 0.85 |
| Fire Rating | CAN/ULC-S102 Class A ASTM E84 Class A |
| Sustainability | 100% Recyclable |
| Warranty | 5 Year Limited |

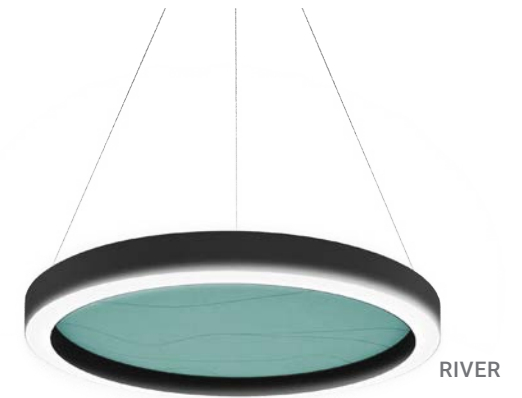

Sunno

GREENGUARD® GOLD CERTIFICATION

Hush Acoustics has achieved full GreenGuard® Gold sustainability certification, a mark of excellence that ensures our products meet strict standards for low chemical emissions, promoting healthier indoor air quality.

SUSTAINABILITY

Manufactured from 100% PET(60% recycled material), our felt products demonstrate our commitment to both environmental stewardship and functional design, contributing to a greener and quieter future. It comprising of flame-retardant fiber as new material ensuring ASTM E84 class A certification. The high strength of PET panels in comparison to its weight is the key to its superior energy efficiency.

FUNGAL RESISTANT

Independently tested by EMSL Canada, Hush P.E.T. felt showed zero mold growth under ASTM C1338 laboratory conditions, confirming exceptional durability.

WARRANTY

5 year limited warranty. See F.A.Q. page on our website for more information.



LIGHT INFORMATION

Ring Color: Matte White or Matte Black

Ring Profile Dimensions:

W 70mm x H 85mm /

W 2.76" x H 3.35

Suspension:

3000 mm / 118.11" Cable & Cord

Delivered Lumens: 499 – 8827

(depending on light diameter)

Type of Dimmer: ELV

CRI: 90+

LED Life: 54Khrs.

Location: Damp Rated

Certification: cULus or Equivalent

Light Feature: 4 CCT and 4 power selectable with direct / indirect light ratio

Ring Diameter: 600 / 900 / 1200 mm /
24 /36 / 48 in

Electrical Cover Diameter: 220 mm / 8.66in

Dimmable: Yes (10v)

Dimming Percentage: 10%-100%

Color Temperature: 3000 / 3500 / 4000 / 5000

LED Type: Module & Driver

Lens: Frosted Polycarbonate

Voltage: 120-347 V

COMPLIMENTARY DOCUMENTATION



Ceiling Hardware
Install Guide



Felt
Maintenance Guide



Flame
Spread



Panel Printing
Protocol

See Resource Hub page on website for more documentation

Sunno

FLAT · RIVER · CURVES · CANVA

| <i>mm</i> | <i>inches</i> |
|------------------|-------------------|
| 600 x 600 x 85 | 23.6 x 23.6 x 3.3 |
| 900 x 900 x 85 | 35.4 x 35.4 x 3.3 |
| 1200 x 1200 x 85 | 47.2 x 47.2 x 3.3 |

RISE

| | |
|-------------------|--------------------|
| 600 x 600 x 300 | 23.6 x 23.6 x 11.8 |
| 900 x 900 x 300 | 35.4 x 35.4 x 11.8 |
| 1200 x 1200 x 300 | 47.2 x 47.2 x 11.8 |

DAWN

| | |
|-------------------|--------------------|
| 600 x 600 x 450 | 23.6 x 23.6 x 17.7 |
| 900 x 900 x 450 | 35.4 x 35.4 x 17.7 |
| 1200 x 1200 x 450 | 47.2 x 47.2 x 17.7 |

NOISE REDUCTION COEFFICIENT COMPARISON

NRC Ring Horizontal Type, 6 pcs (Flat, River, Curves, & Canva)

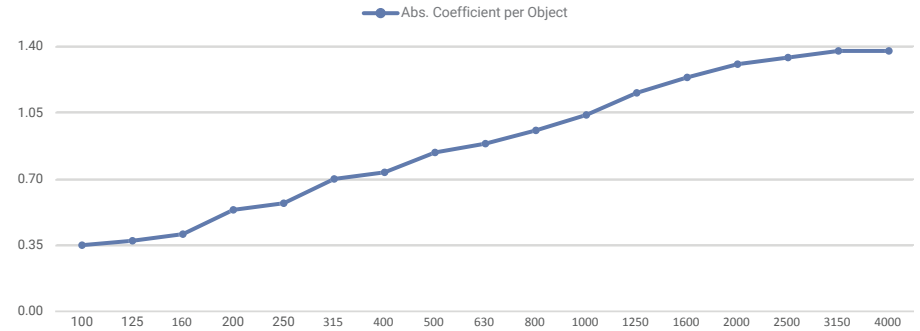

NRC Ring Vertical Type, 6 pcs (Rise & Dawn)

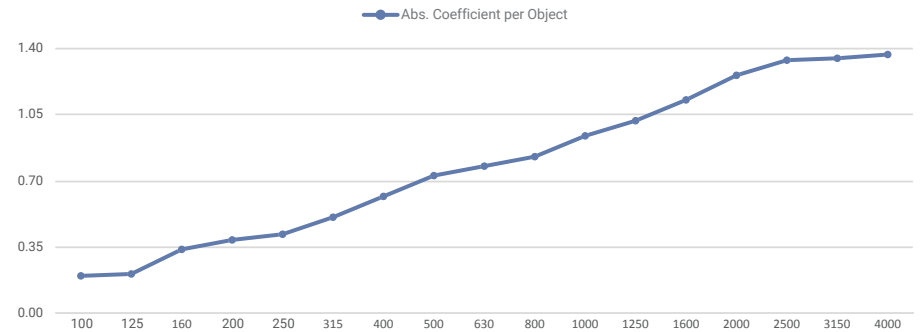

Full NRC comparison available upon request

Sunno

HOW TO SPECIFY

1. Select Design

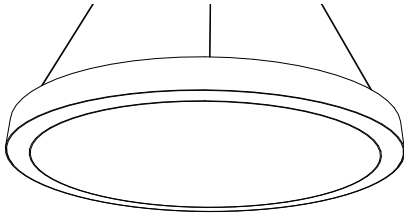

Flat

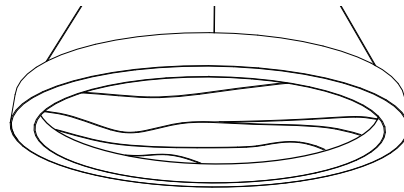

River

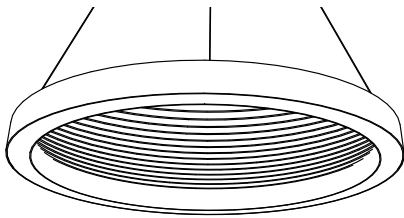

Curves

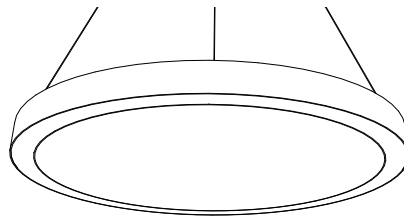

Canva (printed)

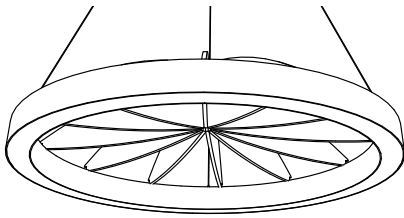

Rise

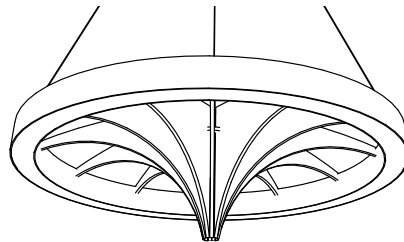

Dawn

2. Select Size

See [page 4](#) for full size chart

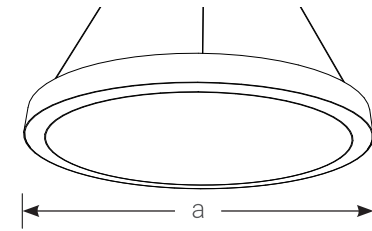

3. Select Color

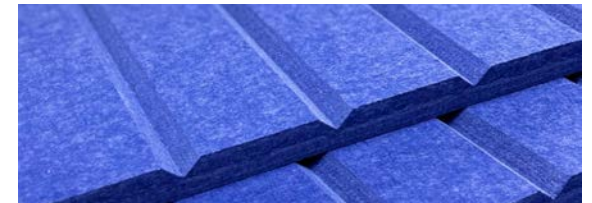

Element



Custom Print · Canva model

Sunno

INSTALLATION INSTRUCTIONS

Flat, River,
Curves, & Canva

Page 7

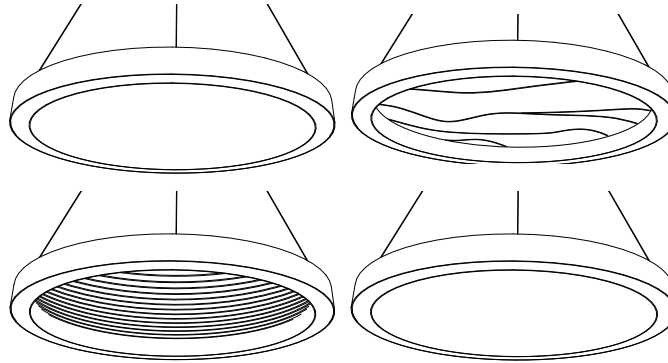

Rise & Dawn

Page 8

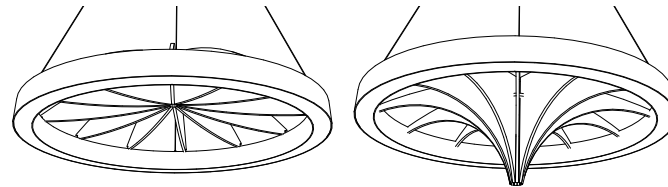

Sunno

INSTALLATION INSTRUCTIONS · *FLAT, RIVER, CURVES & CANVA*

1. Locate the ring light and the acoustic cloud.

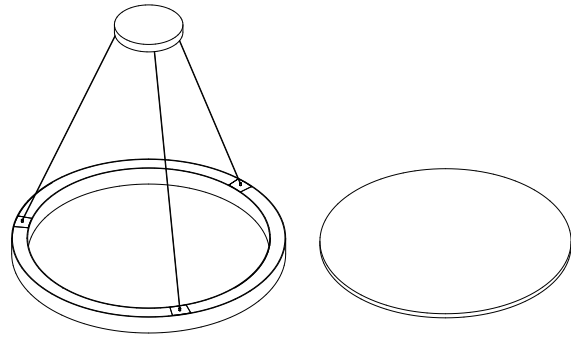

2. Place the acoustic cloud onto the back of the ring light, ensuring that the step on the edge of the cloud is seated on the ring light.

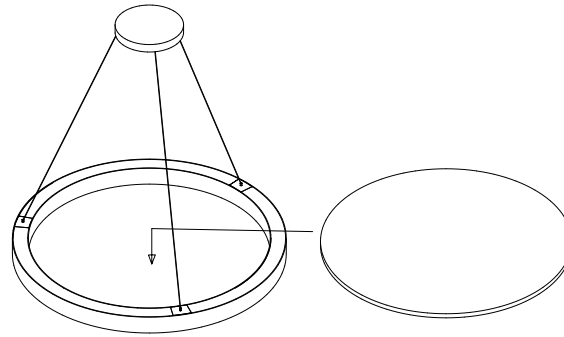

3. Your ring light is now assembled and ready to be installed to the ceiling.

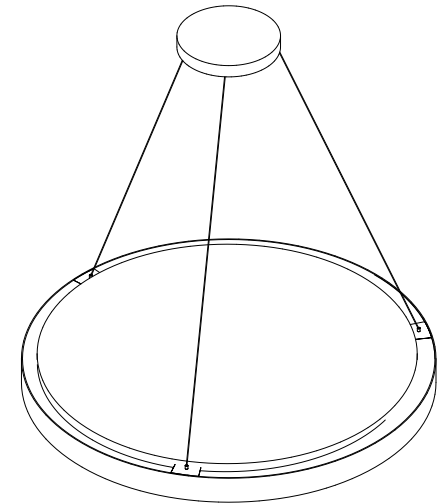

Sunno

INSTALLATION INSTRUCTIONS - RISE & DAWN

1. Locate the ring light, the acoustic blades and the center connector

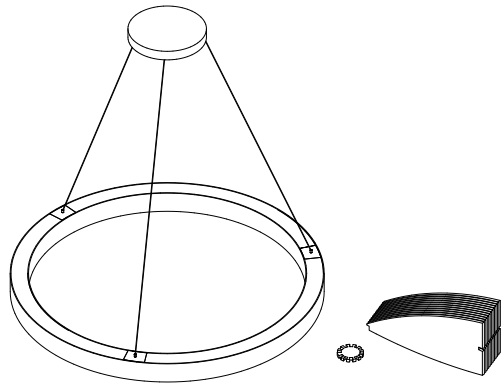

2. Begin by inserting one of the blades into the center connector.

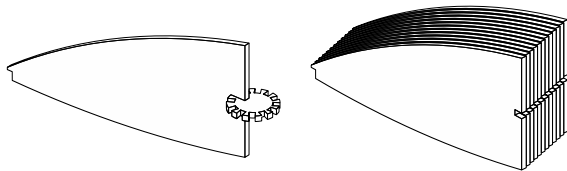

3. Add remaining blades to the center connector, there are 12 blades total per fixture.

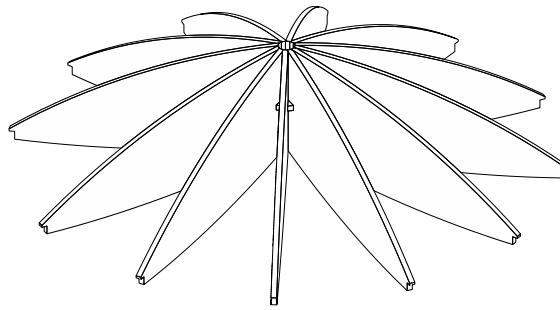

4. Now place the assembled blade set into the Ring Light, ensuring that the notches on the blades are seated onto the Ring Light

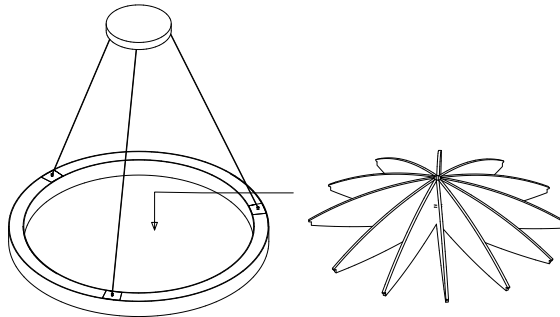

5. The assembly of the Ring Light is now complete and ready to be installed.

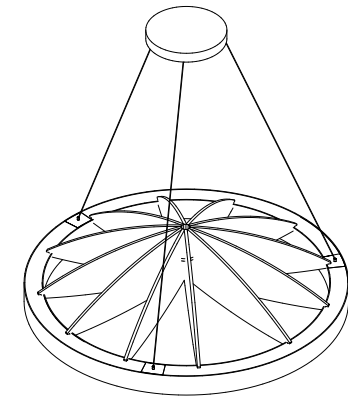

Color Options

PLEASE NOTE: The images are only a sampling of the colors. Order a physical color sample to obtain an accurate representation of our acoustic colors.

ELEMENT



SUNFLOWER



APRICOT



WINE



CHERRY



TAMARIND

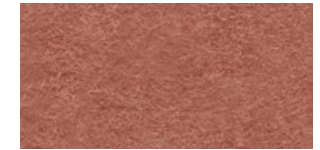

SALMON



GOLD



CARAMEL



CINNAMON



PEARL



MAPLE



MOCHA



MOSS

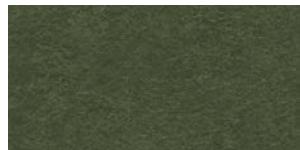

FORREST



CRYSTAL



AQUAMARINE

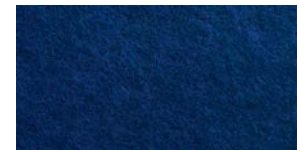

LAPIS



OCEAN



LAKE



ICE



LILAC

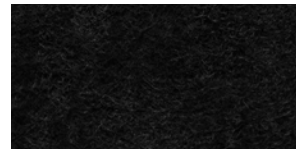

CHARCOAL

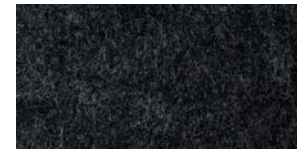

SLATE



OYSTER

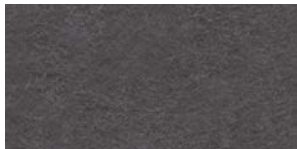

SHADOW



CASPER



FOG



SNOW



VANILLA



Sunno Rise & Flat · Cherry · Work Space

hush.

Tailored for Architects,
Interior Designers, and
General Contractors, we serve
as a fast, expert, and reliable
partner for all your project ideas.

Quiet by Design



Proudly Made
in North America



2 Year
Limited Warranty



**GreenGuard Gold®
Certified**
All Hush products
exceed GreenGuard
Gold® indoor air
quality standards



**Fungal Resistant
Certified**
EMSL Canada verified
zero mold growth
for Hush P.E.T. felt
(ASTM C1338).

hello@hushacousticsusa.com · 1.332.266.9107
733 3rd Ave · Floor 16 #1067
New York, NY 10017 United States

Follow us on Instagram
@hush.acoustics



hushacousticsUSA.com